

描述:

全塑三防(应急)荧光灯壳体和透明罩采用高抗冲击、抗紫外线的聚碳酸酯注塑成型,其稳定性及机械强度高,对工厂中多种化学物质具有良好的防护能力;本灯具采用的材料均能有效地防止有机化合物的腐蚀;密封系统采用双边铰链式锁扣设计,具有防护等级高、开合方便、维修简单等优点;本灯具广泛用于在220V AC、50Hz 线路中作为石油、化工、医药、军工、食品等工厂企业的照明之用。

全塑三防 LED 灯内装“CZ”LED灯管、灯座、接线端子等。

全塑三防荧光灯内装有专用电子镇流器、灯座、接线端子等。

全塑三防(应急)荧光灯内装有专用电子镇流器、逆变器、耐高温电池等。本灯具在正常使用时自动充电,事故断电或停电时自动点亮灯管。

安装形式分为:吸顶式、吊链式、吊杆式、壁式和夹管式。

- 安装形式分为:平台护栏式、平台法兰式。
 - 永不变形的结构设计,防护等级高达IP66。
 - 双边铰链式锁扣设计,开合方便,维修简单
- 外露紧固件设计为不锈钢

● 应急灯具安装线路图 Mounting circuit diagram for emergency light fittings



Descriptions:

The enclosures and the transparent shields of full plastic weather-proof (emergency) fluorescent light fittings are made of polycarbonate, which is highly stable, has strong mechanical strength and good resistance against many kinds of chemical matters in factories. The material of the light fitting can also prevent organic corrosion effectively. The double sides articulated claps type is designed in the sealing system, which has the characters of high degree of protection, opening and closing conveniently and maintained conveniently. The full plastic weather-proof (emergency) fluorescent light fitting is widely used for illuminating of petroleum, petrochemical, medical, military, food and power supply industries in the circuit of 220V AC, 50Hz.

“CZ” LED lamp tube, light fitting lampholder, terminal so on are built-in full plastic weather-proof LED light fittings. The full plastic weather-proof fluorescent light fitting is fitted with special electronic ballast, lampholder, and terminals and so on.

The full plastic weather-proof (emergency) fluorescent light fitting is mounted with special electronic ballast, inverter, and high temperature resistance battery and so on. It can automatically be recharged while normal working, so that the lamp tube will be turned on when the power is off because of accident or power failure.

The mounting ways are ceiling type, chain type, pendant type, wall type and clap type.

The mounting ways are platform fence and platform flange type.

- The structural design will never be distorted and the degree of protection is up to IP66.
- The double sides articulated claps type is designed and it is convenient to be opened and closed and be maintained.
- The exposed fasteners are made of stainless steel.

● 主要数据 Main technical data:

防腐标志: WF2
防护等级: IP66
额定电压: 220-240V AC 50/60Hz
功率因数: $\lambda > 0.95$
能效指数 EEI=A2
镇流器: 电子式
接线端子: L、N、PE, 每个端子 $2 \times 1.5-10\text{mm}^2$
电缆入口: 塑制 $1 \times M25 \times 1.5$, 电缆外径: $\Phi 8-17\text{mm}$
塑制 $2 \times M25 \times 1.5$ 空塞堵头
注: 内装镇流器可按用户要求选用指定品牌

Corrosion-proof mark: WF2
Degree of protection: IP66
Rated voltage: 220-240V AC 50/60Hz
Power factor: $\lambda > 0.95$
Energy efficiency index EEI=A2
Ballast: Electronic type
Terminals: L、N、PE, each terminal $2 \times 1.5-10\text{mm}^2$
Cable entry: Moulded plastic $1 \times M25 \times 1.5$ cable gland,
Outside diameter of cable: $\Phi 8-17\text{mm}$
Moulded plastic $2 \times M25 \times 1.5$ stopping plugs
Note: The specified brand of the built-in ballast can be used as
per user's requirements.

● 主要数据 Main technical data:

防腐标志: WF2
 防护等级: IP66
 额定电压: 220-240V AC 50/60Hz
 功率因数: $\lambda > 0.95$
 能效指数 EEI=A2
 镇流器: 电子式
 充电时间: 24 h
 应急启动时间: 0.1 (S)
 应急照明时间: > 120 (min)
 接线端子: L1、L2、N、PE, 每个端子 2 × 1.5-10mm²
 电缆入口: 塑制 1 × M25 × 1.5, 电缆外径: $\Phi 8-17\text{mm}$
 塑制 2 × M25 × 1.5 空塞堵头
 注: 内装镇流器可按用户要求选用指定品牌

Corrosion-proof mark: WF2
 Degree of protection: IP66
 Rated voltage: 220-240V AC 50/60Hz
 Power factor: $\lambda > 0.95$
 Energy efficiency index EEI=A2
 Ballast: Electronic type
 Recharging time: 24 h
 Emergency starting time: 0.1 (S)
 Emergency illuminating time: > 120 (min)
 Terminals: L1, L2, N, PE, each terminal 2 × 1.5-10mm²
 Cable entry: Moulded plastic 1 × M25 × 1.5 cable gland,
 Outside diameter of cable: $\Phi 8-17\text{mm}$
 Moulded plastic 2 × M25 × 1.5 Stopping plugs
 Note: The specified brand of the built-in ballast can be used as per user's request.

● 订购规格 Order specifications:

图样 Illustration	灯座代号 Lampholder code	镇流器 Ballast	正常照明 Normal illumination	应急照明 Emergency illumination	重量 Weight	订购号 Order No.
 M0875	G5 双脚灯座 G5 Two-pin lampholder	电子式 Electronic type	2 × 14W	1 × 14W	4.9kg	M0875/2 × 14WE YJ -B+
	G5 双脚灯座 G5 Two-pin lampholder	电子式 Electronic type	2 × 28W	1 × 28W	6.65kg	M0876/2 × 28WE YJ -B+
 M0876	G13 双脚灯座 G13 Two-pin lampholder	电子式 Electronic type	2 × 18W	1 × 18W	5kg	M0875/2 × 18WE YJ -B+
	G13 双脚灯座 G13 Two-pin lampholder	电子式 Electronic type	2 × 36W	1 × 36W	6.72kg	M0876/2 × 36WE YJ -B+

电缆引入装置编码 Code of cable gland ◀
 安装附件订购号, 不配不注, 见 215-216页 ◀
 Order No. of mounting accessories (No matching not listed) see page 215-216

● 电缆引入装置编码 Code of cable gland

编码 Code	规格 Specifications	电缆直径 Cable diameter
B	塑制 1 个 M25 × 1.5 电缆密封套, 塑制 2 个 M25 × 1.5 空塞堵头 One moulded plastic M25 × 1.5 cable gland, two moulded plastic M25 × 1.5 stopping plugs	$\Phi 8-17\text{mm}$
C	铜制 1 个 C/0221 M25 × 1.5 金属电缆密封套, 塑制 2 个 M25 × 1.5 空塞堵头 One brass C/0221 M25 × 1.5 metal cable gland, two moulded plastic M25 × 1.5 stopping plugs	$\Phi 8-17\text{mm}$
D	塑制 2 个 M25 × 1.5 电缆密封套, 塑制 1 个 M25 × 1.5 空塞堵头 Two moulded plastic M25 × 1.5 cable glands, one moulded plastic M25 × 1.5 stopping plug	$\Phi 8-17\text{mm}$
F	铜制 2 个 C/0221 M25 × 1.5 金属电缆密封套, 塑制 1 个 M25 × 1.5 空塞堵头 Two brass C/0221 M25 × 1.5 metal cable glands, one moulded plastic M25 × 1.5 stopping plug	$\Phi 8-17\text{mm}$
F	铜制 1 个 C/0227 M25 × 1.5 G ¹ 增强型金属电缆密封套, 塑制 2 个 M25 × 1.5 空塞堵头 One brass C/0227 M25 × 1.5 G ¹ increased safety metal cable gland, two moulded plastic M25 × 1.5 stopping plugs	$\Phi 11-15\text{mm}$
G	铜制 2 个 C/0227 M25 × 1.5 G ¹ 增强型金属电缆密封套, 塑制 1 个 M25 × 1.5 空塞堵头 Two brass C/0227 M25 × 1.5 G ¹ increased safety metal cable glands, one moulded plastic M25 × 1.5 stopping plugs	$\Phi 11-15\text{mm}$
H	铜制 1 个 C/0226 M25 × 1.5 G ² 增强型金属电缆密封套(填充箱), 塑制 2 个 M25 × 1.5 空塞堵头 One brass C/0226 M25 × 1.5 G ² increased safety metal cable gland (stopping boxes), two moulded plastic M25 × 1.5 stopping plugs	$\Phi 11.5-19\text{mm}$
I	铜制 2 个 C/0226 M25 × 1.5 G ² 增强型金属电缆密封套(填充箱), 塑制 1 个 M25 × 1.5 空塞堵头 Two brass C/0226 M25 × 1.5 G ² increased safety metal cable glands (stopping boxes), one moulded plastic M25 × 1.5 stopping plug	$\Phi 11.5-19\text{mm}$

● 安装附件 Accessories of mounting:

图样 Illustration	描述 Descriptions	单位 Unit	订购号 Order No.
吊杆式附件 Accessories for pendant type 		套Set	D622
吊链式附件 Accessories for chain type 		套Set	D623
夹管附件M8螺钉安装 Accessories for clamp tube M8 for screw mounting 	G1 1/4" Φ42mm 钢制 Steel 	套Set	J200
可调式支架 Support for ceiling type 	G1 1/4" Φ42mm 不锈钢 Stainless steel 	套Set	J200/304
可调安装支架 Adjustable mounting bracket 	G1 1/4" Φ48mm 钢制 Steel 	套Set	J300
耳架安装支架 Mounting bracket of ear demel. 	G1 1/4" Φ48mm 不锈钢 Stainless steel 	套Set	J300/304
可调式支架 Support for ceiling type 	G2 Φ60mm 钢制 Steel 	套Set	J400
可调式支架 Ceiling bracket 	G2 Φ60mm 不锈钢 Stainless steel 	套Set	J400/304
可调式支架 Support for ceiling type 	钢制 Steel 	套Set	D621
可调式支架 Support for ceiling type 	不锈钢 Stainless steel 	套Set	D621/304
可调式支架 Support for ceiling type 	可调安装支架 Adjustable mounting bracket 	套Set	D8738
耳架安装支架 Mounting bracket of ear demel. 	耳架安装支架 Mounting bracket of ear demel. 	套Set	D8730/1
可调式支架 Ceiling bracket 	材质: 304 不锈钢 Material: 304 stainless steel 	套Set	D8727
壁式灯杆 Lamp pole of wall type 	用于 T1 D12W、14W、18W 荧光灯 Used for 12W、14W、18W fluorescent light fittings 	套Set	D8709/1A
杆式灯杆 Lamp pole of fence type 	用于 T1 D23W、28W、36W 荧光灯 Used for 23W、28W、36W fluorescent light fittings 	套Set	D8709/2A
杆式灯杆 Lamp pole of fence type 	用于 T1 D12W、14W、18W 荧光灯 Used for 12W、14W、18W fluorescent light fittings 	套Set	D8710/1A
杆式灯杆 Lamp pole of fence type 	用于 T1 D23W、28W、36W 荧光灯 Used for 23W、28W、36W fluorescent light fittings 	套Set	D8710/2A
法兰式灯杆 Lamp pole of flange type 	用于 T1 D12W、14W、18W 荧光灯 Used for 12W、14W、18W fluorescent light fittings 	套Set	D8711/1A
法兰式灯杆 Lamp pole of flange type 	用于 T1 D23W、28W、36W 荧光灯 Used for 23W、28W、36W fluorescent light fittings 	套Set	D8711/2A
接地螺母 Earthing nut 	全锡接地螺母 2-M25 × 1.5 Metal earthing nut 2-M25 × 1.5 	套Set	D8714/2-M25

• 安装形式和外形尺寸 Mounting ways and outline dimensions:

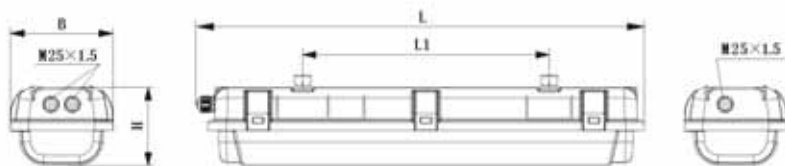

全塑三防荧光灯
Full plastic weather-proof fluorescent light fittings

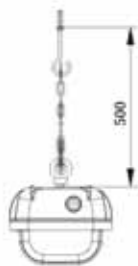

吊链式安装
Chain type

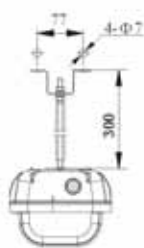

吊杆式安装
Pendant type

型号 Type	M0875 LED 2 × 12W 2 × 14W(18W)	M0876 LED 2 × 23W 2 × 28W(36W)
L	730	1330
L1	400	800
L2	470	870
L3	800	1300
B	168	168
H	128	128
H1	2510	2510
H2	2500	2500
H3	1050	1050

G1 1/4" Φ42mm
G1 1/2" Φ48mm
G2" Φ60mm

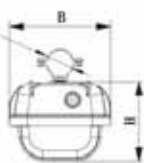

夹管式安装
Clamp type

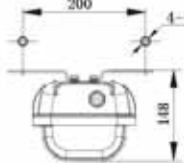

吸顶式安装 II
Ceiling type II

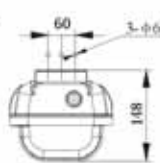

吸顶式安装 I
Ceiling type I

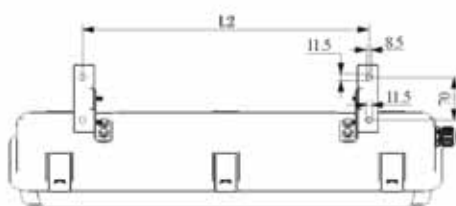
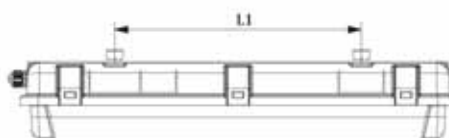

可调支架安装
Adjustable mounting bracket

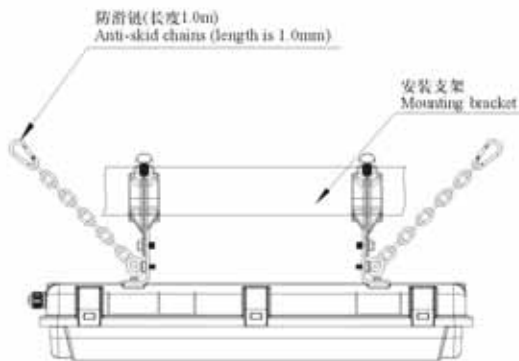
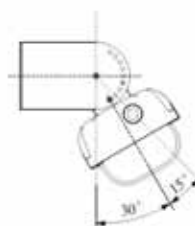

支架式安装 Bracket

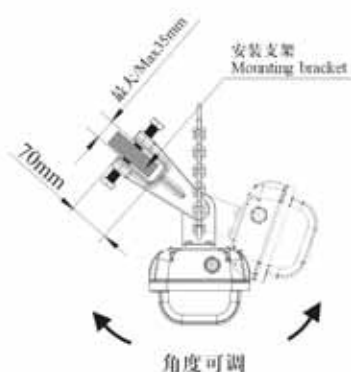

角度可调

- 安装形式和外形尺寸 Mounting ways and outline dimensions:

