



描述

三防高顶灯外壳由铝合金压铸成型，表面喷涂纯环氧树脂粉末，抗腐蚀性能好。铝罩套件采用高纯铝反射器，阳极氧化处理，反射效率高；透明件采用钢化玻璃。特殊持久的密封结构，紧固件采用不锈钢材料。三防高顶灯从侧面进线，适用于橡套电缆布线，内部接线端子选用笼式端子，便于接线。三防高顶灯内部独特的隔热和散热设计，使灯具散热效果更佳。能满足

• 配光曲线 Luminous intensity distribution curve:

光强单位 luminous intensity unit: cd/1000 Lm

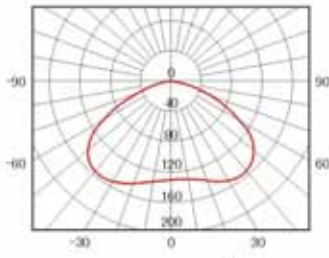

M087D-JN45W 节能灯
Energy-saving lamp

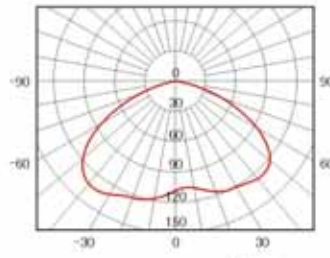

M087D-JN65W 节能灯
Energy-saving lamp

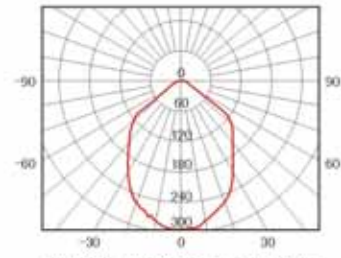

M087D-J70W 金属卤化物灯
Metal halide lamp

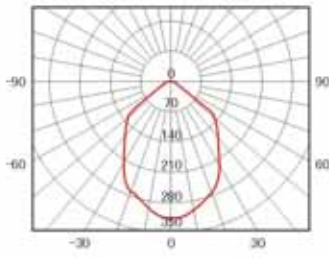

M087D-J150W 金属卤化物灯
Metal halide lamp

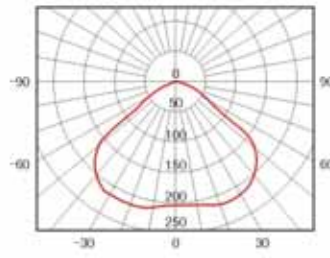

M087D-J250W 金属卤化物灯
Metal halide lamp

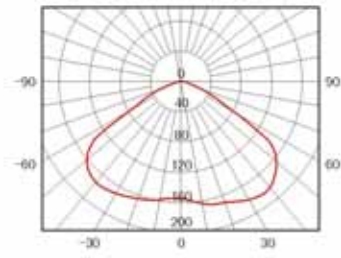

M087D-J400W 金属卤化物灯
Metal halide lamp

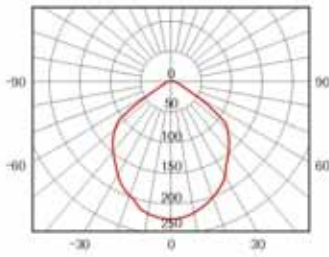

M087D-N70W 高压钠灯
High pressure sodium vapor lamp

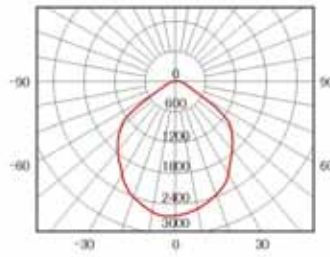

M087D-N100W 高压钠灯
High pressure sodium vapor lamp

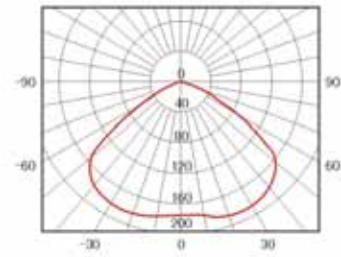

M087D-N250W 高压钠灯
High pressure sodium vapor lamp

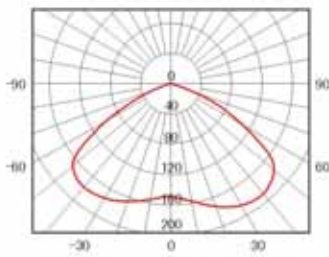

M087D-N400W 高压钠灯
High pressure sodium vapor lamp

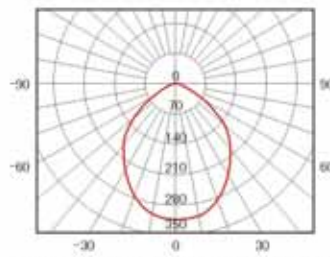

M087D-QL85W 电磁感应节能灯
Electromagnetic induction
energy-saving lamp

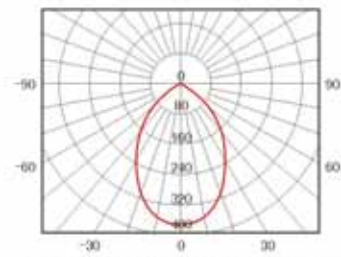

M087D-QL135W 电磁感应节能灯
Electromagnetic induction
energy-saving lamp

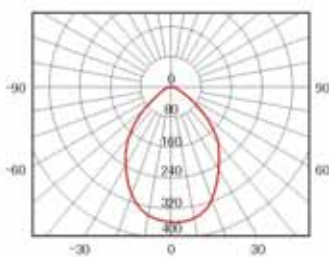

M087D-QL165W 电磁感应节能灯
Electromagnetic induction
energy-saving lamp

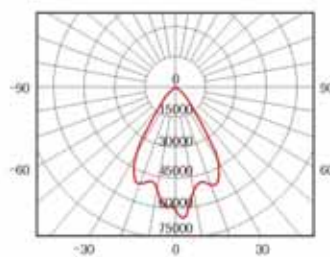

M087D-J1000W 金属卤化物灯
Metal halide lamp

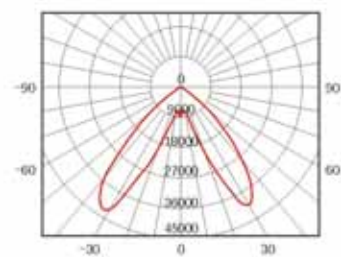



M087D-J1000W 金属卤化物灯
Metal halide lamp

● 主要数据 Main technical data:

防腐标志: WF1
 防护等级: IP66
 额定电压: 220V AC 50Hz
 220V AC, 230V AC, 240V AC 50Hz, 60Hz
 使用环境温度: $-40^{\circ}\text{C} < \text{Ta} < 50^{\circ}\text{C}$
 接线端子: L1, N 笼式端子 $2 \times 2.5\text{mm}^2$, PE 端子 $2 \times 10\text{mm}^2$
 电缆入口: 塑制 $1 \times \text{M}25 \times 1.5$, 电缆外径: $\Phi 8\text{-}17\text{mm}$
 塑制 $3 \times \text{M}25 \times 1.5$ 空塞堵头

Corrosion-proof mark: WF1
 Degree of protection: IP66
 Rated voltage: 220V AC 50Hz
 220V AC, 230V AC, 240V AC 50Hz, 60Hz
 Ambient temperature: $-40^{\circ}\text{C} < \text{Ta} < 50^{\circ}\text{C}$
 Terminal: L1, N cage type terminal $2 \times 2.5\text{mm}^2$,
 PE terminal: $2 \times 10\text{mm}^2$
 Cable entry: Moulded plastic $1 \times \text{M}25 \times 1.5$,
 Outside diameter: $\Phi 8\text{-}17\text{mm}$
 Moulded plastic $3 \times \text{M}25 \times 1.5$ stopping plugs

● 订购规格 Order specifications:

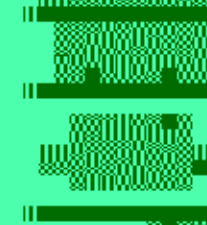
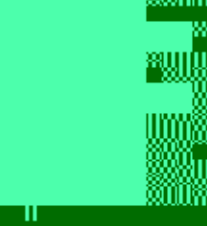
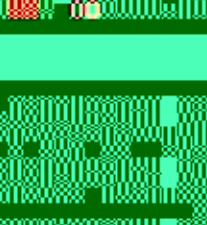
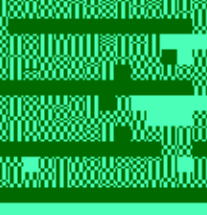
图样 Illustration	光源代号 Code of light source	灯座代号 Lampholder code	功率 Power	重量 Weight	订购号 Order No.
	节能灯-JN	E27	45W	0.25kg	087D/1-JN-E27-45W
	节能灯-JN	E27	45W	0.25kg	087D/2-JN-E27-45W
	节能灯-JN	E27	45W	0.25kg	087D/3-JN-E27-45W
	节能灯-JN	E27	45W	0.25kg	087D/4-JN-E27-45W
	节能灯-JN	E27	45W	0.25kg	087D/5-JN-E27-45W
	节能灯-JN	E27	45W	0.25kg	087D/6-JN-E27-45W

● **主要数据 Main technical data:**

防腐标志: WF1
 防护等级: IP66
 额定电压: 220V AC 50Hz
 220V AC, 230V AC, 240V AC 50Hz, 60Hz
 使用环境温度: $-40^{\circ}\text{C} < \text{Ta} < 50^{\circ}\text{C}$
 接线端子: L1, N 笼式端子 2-2.5mm², PE 端子 2 × 10mm²
 电缆入口: 塑制 1 × M25 × 1.5, 电缆外径: $\Phi 8-17\text{mm}$
 塑制 3 × M25 × 1.5 空塞堵头

Corrosion-proof mark: WF1
 Degree of protection: IP66
 Rated voltage: 220V AC 50Hz
 220V AC, 230V AC, 240V AC 50Hz, 60Hz
 Ambient temperature: $-40^{\circ}\text{C} < \text{Ta} < 50^{\circ}\text{C}$
 Terminal: L1, N cage type terminal 2-2.5mm²,
 PE terminal: 2 × 10mm²
 Cable entry: Moulded plastic 1 × M25 × 1.5,
 Outside diameter: $\Phi 8-17\text{mm}$
 Moulded plastic 3 × M25 × 1.5 stopping plugs

● **订购规格 Order specifications:**

图样 Illustration	光源代号 Code of light source	灯座代号 Lampholder code	配光曲线 Lampholder code	功率 Power	重量 Weight	订购号 Order No.
 M087D/3	金属卤化物灯-J Metal halide lamp-J	E40	中配光 Medium light distribution	1000W	20kg	M087D/3-J1000W25-MB-13+ □
		E40	中宽配光 Medium wide distribution	1000W	20kg	M087D/3-J1000W25-MW-13+ □
	高压钠灯-N High pressure sodium vapor lamp-N	E40	中配光 Medium light distribution	1000W	20kg	M087D/3-N1000W25-MB-13+ □
		E40	中宽配光 Medium wide distribution	1000W	20kg	M087D/3-N1000W25-MW-13+ □

额定电压 Rated voltage ←
 2 — 220V AC 3 — 230V AC 4 — 240V AC
 额定频率 Rated frequency ←
 5 — 50Hz 6 — 60Hz
 电缆引入装置编码 Code of cable gland ←
 安装附件订购号 (不配不注) 见 185 页 ←
 Order No. of mounting accessories (No matching not noted), see page 185

● **电缆引入装置编码 Code of cable gland**

编码 Code	规格 Specification	电缆直径 Cable diameter
13	塑制 1 个 M25 × 1.5 电缆密封套, 塑制 3 个 M25 × 1.5 空塞堵头 One moulded plastic M25 × 1.5 cable gland, three moulded plastic M25 × 1.5 stopping plugs.	$\Phi 8-17\text{mm}$
22	塑制 2 个 M25 × 1.5 电缆密封套, 塑制 2 个 M25 × 1.5 空塞堵头 Two moulded plastic M25 × 1.5 cable glands, two moulded plastic M25 × 1.5 stopping plugs.	$\Phi 8-17\text{mm}$
31	塑制 3 个 M25 × 1.5 电缆密封套, 塑制 1 个 M25 × 1.5 空塞堵头 Three moulded plastic M25 × 1.5 cable glands, one moulded plastic M25 × 1.5 stopping plug.	$\Phi 8-17\text{mm}$
40	塑制 4 个 M25 × 1.5 电缆密封套 Four moulded plastic M25 × 1.5 cable glands	$\Phi 8-17\text{mm}$
04	塑制 4 个 M25 × 1.5 空塞堵头 Four moulded plastic M25 × 1.5 stopping plugs.	

注: 如配金属电缆密封套, 在编码后注明。 Note: If matched with metal cable gland, note after code.

● **配光曲线 Luminous intensity distribution curve:**

光强单位 luminous intensity unit: cd/1000 Lm

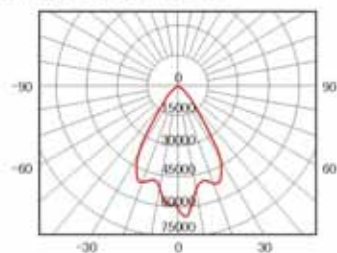

M087D-J1000W 金属卤化物灯
Metal halide lamp
MB—中配光
MB-Medium light distribution

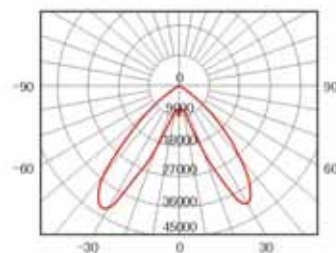

M087D-J1000W 金属卤化物灯
Metal halide lamp
MW—中宽配光
MW-Medium wide distribution



描述

三防应急高顶灯外壳由铝合金压铸成型，表面喷涂纯环氧树脂粉末，抗腐蚀性能好。铝罩套件采用高纯铝反射器，阳极氧化处理，反射效率高；透明件采用钢化玻璃。特殊持久的密封结构，紧固件采用不锈钢材料。三防高顶灯从侧面进线，适用于橡胶套电缆布线，内部接线端子选用笼式端子，便于接线。三防应急高顶灯内部独特的隔热和散热设计，使灯具散热效果更佳。能满足石油、化工、医药、军工、食品、电厂等企业的照明之用。

三防应急高顶灯内配有三防照明开关、逆变器、锂电池和金属卤化物灯泡。

三防应急高顶灯安装形式可分为吸顶式、吊杆式、吊链式。

- 防护等级高达IP66
- 安装维护方便

Descriptions

The enclosures of weather-proof emergency high dome light fittings are made of die-cast aluminum alloy, with epoxy resin powder sprayed on their surfaces, so that they have good anti-corrosion performance. The aluminum cover is made by high-purity aluminum reflector, which has been anodized and has high reflectivity. The transparent shield is made by the toughened glass of borosilicate, with a special and durable sealing structure, and the exposed fasteners are made of stainless steel. Weather-proof emergency dome light fitting's terminal box side entry, is suitable for rubber-coated and wiring. The cage type terminals are selected as the internal terminals, which are convenient for wiring. The unique heat insulation design united with the exterior high density radiator in the weather-proof emergency dome light fitting to cause the radiation effect will be better. It can satisfy the related requirements of illumination in petroleum, petrochemical, medical, military, food and power supply industries.

The electronic ballast, inverter, lithium battery and metal halide lamp are built-in the weather-proof emergency dome light fittings.

The mounting ways of the weather-proof dome emergency light fittings are ceiling type, pendant pole type and chain type.

- The degree of protection is up to IP66.
- It is convenient to be mounted and maintained.

● 应急灯具安装线路图

Standard mounting circuit diagram for emergency light fittings:

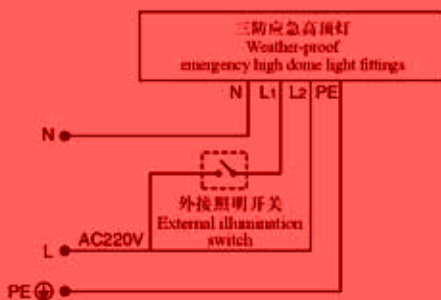

● 配光曲线 Luminous intensity distribution curve:

光强单位 luminous intensity unit: cd/1000 Lm

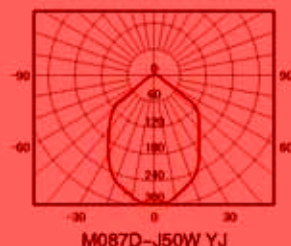

● **主要数据 Main technical data:**

防腐标志: WF1	Corrosion-proof mark: WF1
防护等级: IP66	Degree of protection: IP66
额定电压: 160 – 260V AC 50/60Hz	Rated voltage: 160 – 260V AC 50/60Hz
充电时间: 24h	Recharging time: 24 (h)
应急启动时间: 0.1 (S)	Emergency starting time: 0.1 (s)
应急照明时间: >60 (min)	Emergency illuminating time: >60 (min)
使用环境温度: -40℃ < Ta < 50℃	Ambient temperature: -40℃ < Ta < 50℃
接线端子: L1, N 笼式端子 2-2.5mm ² , PE 端子 2 × 10mm ²	Terminal: L1, N cage type terminal 2-2.5mm ² , PE terminal: 2 × 10mm ²
电缆入口: 塑制 1 × M25 × 1.5, 电缆外径: Φ8-17mm	Cable entry: Moulded plastic 1 × M25 × 1.5, Outside diameter: Φ8-17mm
塑制 3 × M25 × 1.5 空塞堵头	Moulded plastic 3 × M25 × 1.5 stopping plugs

● **订购规格 Order specifications:**

图样 Illustration	光源代号 Code of light source	灯座代号 Lampholder code	功率 Power	重量 Weight	订购号 Order No.
	金属卤化物灯-J Metal halide lamp-J	E27	50W	8.5kg	M087D/1-J50W YJ-13+ <input type="checkbox"/>
	<p>电缆引入装置编码 Code of cable gland ←</p> <p>安装附件订购号 (不配不注) 见 185 页 ← Order No. of mounting accessories (No matching not noted), see page 185</p>				

M087D/1

● **电缆引入装置编码 Code of cable gland**





编码 Code	规格 Specification	电缆直径 Cable diameter
13	塑制 1 个 M25 × 1.5 电缆密封套, 塑制 3 个 M25 × 1.5 空塞堵头 One moulded plastic M25 × 1.5 cable gland, three moulded plastic M25 × 1.5 stopping plugs.	Φ8-17mm
22	塑制 2 个 M25 × 1.5 电缆密封套, 塑制 2 个 M25 × 1.5 空塞堵头 Two moulded plastic M25 × 1.5 cable glands, two moulded plastic M25 × 1.5 stopping plugs.	Φ8-17mm
31	塑制 3 个 M25 × 1.5 电缆密封套, 塑制 1 个 M25 × 1.5 空塞堵头 Three moulded plastic M25 × 1.5 cable glands, one moulded plastic M25 × 1.5 stopping plug.	Φ8-17mm
40	塑制 4 个 M25 × 1.5 电缆密封套 Four moulded plastic M25 × 1.5 cable glands	Φ8-17mm
04	塑制 4 个 M25 × 1.5 空塞堵头 Four moulded plastic M25 × 1.5 stopping plugs.	

注: 如配金属电缆密封套, 在编码后注明。 Note: If matched with metal cable gland, note after code.

● **安装形式和外形尺寸图见 186 页 M087D/1 三防高顶灯。**
Mounting way and outline dimensions see page 186, weather-proof high dome light fittings M087D/1.

注: 如需选购其它电缆密封套, 请参见 244 页。
Note: Please see page 244 for other cable glands.

● 安装附件、备件 Mounting accessories, spare parts:

图样 Illustration	描述 Descriptions	单位 Unit	订购号 Order No.
吊式安装支架 Mounting bracket of pendant type 	用于 M087D/1、2 灯具, 材料为优质钢表面喷塑处理 Used for M087D/1、2 light fittings, the material is high quality steel with sprayed plastic surface	套 Set	D8702/2
	用于 M087D/3 灯具, 材料为优质钢表面喷塑处理 Used for M087D/3 light fittings, the material is high quality steel with sprayed plastic surface	套 Set	D8702/3
G3/4"-300mm直管 Straight pipe 	用于灯具吊杆式 For pendant type light fittings	套 Set	D732
吊链式附件(500mm) Chain type accessories 	M8 吊环螺钉安装, 材料为优质钢表面镀锌处理 For M8 lifting eye bolt, the material is high quality steel with galvanization on surface	套 Set	D623
铝罩套件 Aluminum cover kit 	用于 M087D/1 灯具 16 寸铝罩套件 The 16-inch aluminum cover kit can be used to the M087D / 1 light fitting	套 Set	D8721/1
	用于 M087D/2 灯具 19 寸铝罩套件 The 19-inch aluminum cover kit can be used to the M087D / 2 light fitting	套 Set	D8721/2
	用于 M087D/3 灯具 22 寸铝罩套件 The 22-inch aluminum cover kit can be used to the M087D / 3 light fitting	套 Set	D8721/3
陶瓷灯座 Ceramics lampholder 	规格 Specification: E27	只 Piece	K547H
	规格 Specification: E40	只 Piece	132/E40

● 光源备件 Spare parts of light source:

图样 Illustration	功率 Power	灯座 Lampholder	光通量 Luminous flux	单位 Unit	订购号 Order No.
欧司朗品牌节能灯泡(螺旋型) "OSRAM" energy-saving lamp bulb (Helix type) 	45W	E27	2850lm	只 Piece	OSRAM/45W
	65W	E27	4000lm		OSRAM/65W
电磁感应节能灯泡体 Electromagnetic induction energy-saving lamp 	50W	电磁感应 节能灯泡体 Electromagnetic induction energy-saving lamp bulb	2800lm	只 Piece	WJ50T
	85W		5600lm		WJ85P
	135W		8800lm		WJ135PA
	165W		10000lm		WJ165PA
高频发生器 High frequency generator 	50W	高频发生器 High frequency generator		只 Piece	HFG-50AC
	85W		HFG-85AC		
	135W		HFG-135AC		
	165W		HFG-165AC		
金属卤化物灯泡-J Metal halide lamp bulb-J 	50W	E27	3400lm	只 Piece	JL Z50KN
	70W	E27	5000lm		HQI - E 70/N
	100W	E27	8700lm		HQI - E 100/N
	150W	E27	12500lm		HQI - E 150/N
	250W	E40	20500lm		HQI - T 250/D
	400W	E40	32000lm		HQI - T 400/D
	1000W	E40	81500lm		HQI - T 1000/D
高压钠灯灯泡-N High pressure sodium vapor lamp bulb-N 	70W	E27	5900lm	只 Piece	NAV - T 70
	100W	E27	10000lm		NAV - T 100SUPER
	150W	E40	14500lm		NAV - T 150
	250W	E40	27000lm		NAV - T 250
	400W	E40	48000lm		NAV - T 400
	1000W	E40	115000lm		NAV - T 1000

• 外形及安装尺寸 Outline and installation dimensions:

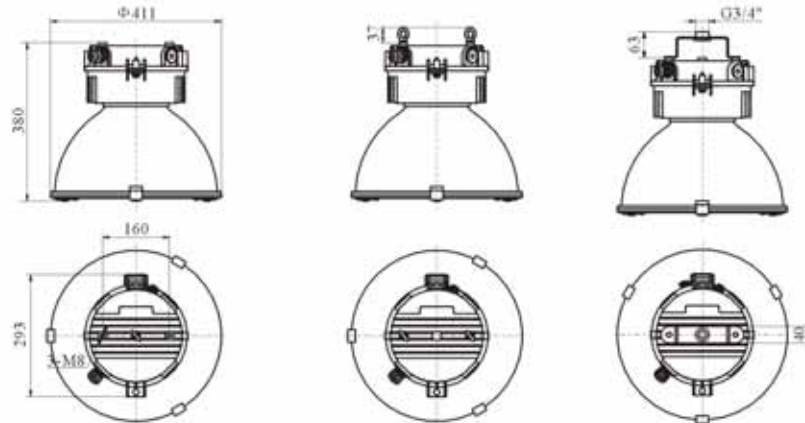

M087D/1 三防高顶灯 M087D/1 Weather-proof high dome light fittings

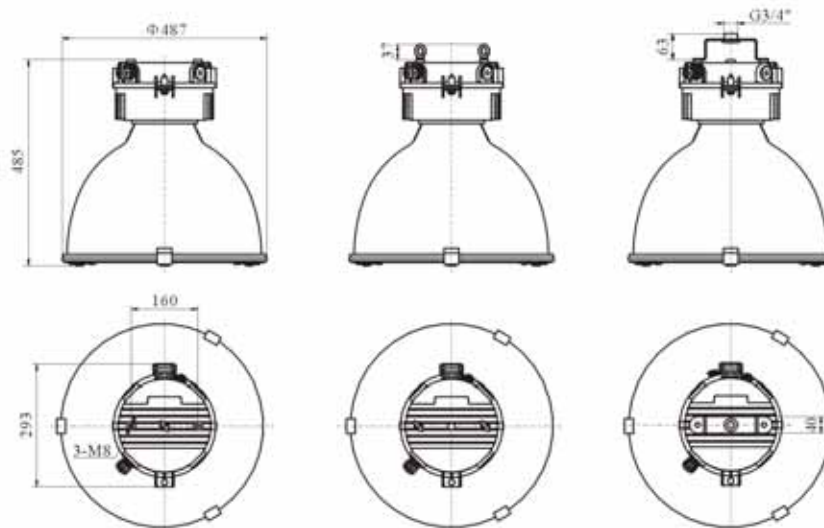

M087D/2 三防高顶灯 M087D/2 Weather-proof high dome light fittings

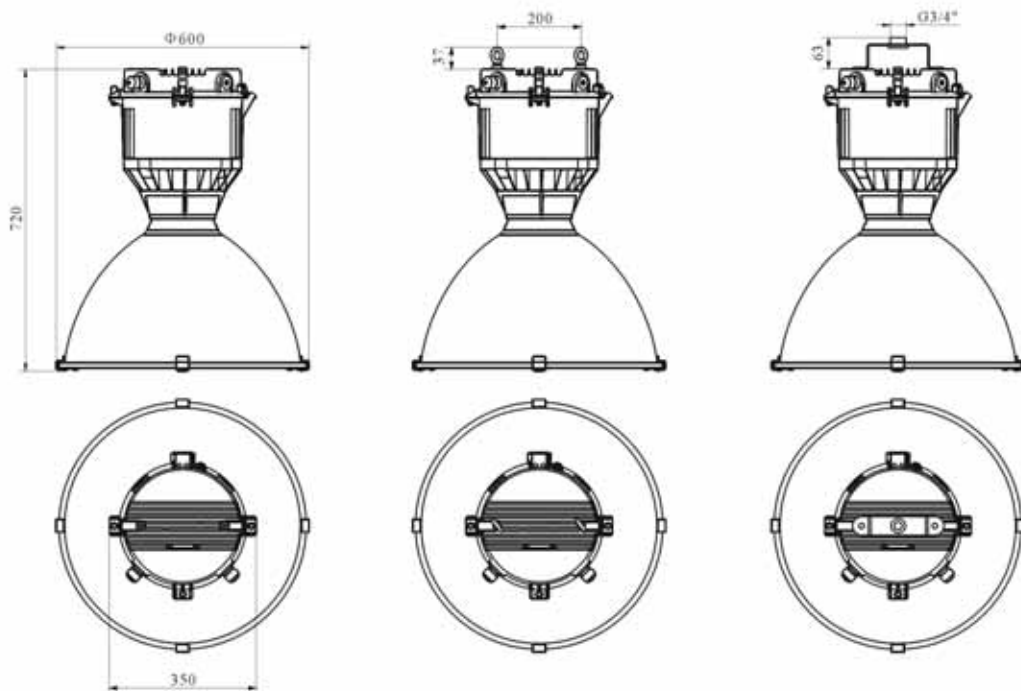

M087D/3 三防高顶灯 M087D/3 Weather-proof high dome light fittings